

ROUTE 1

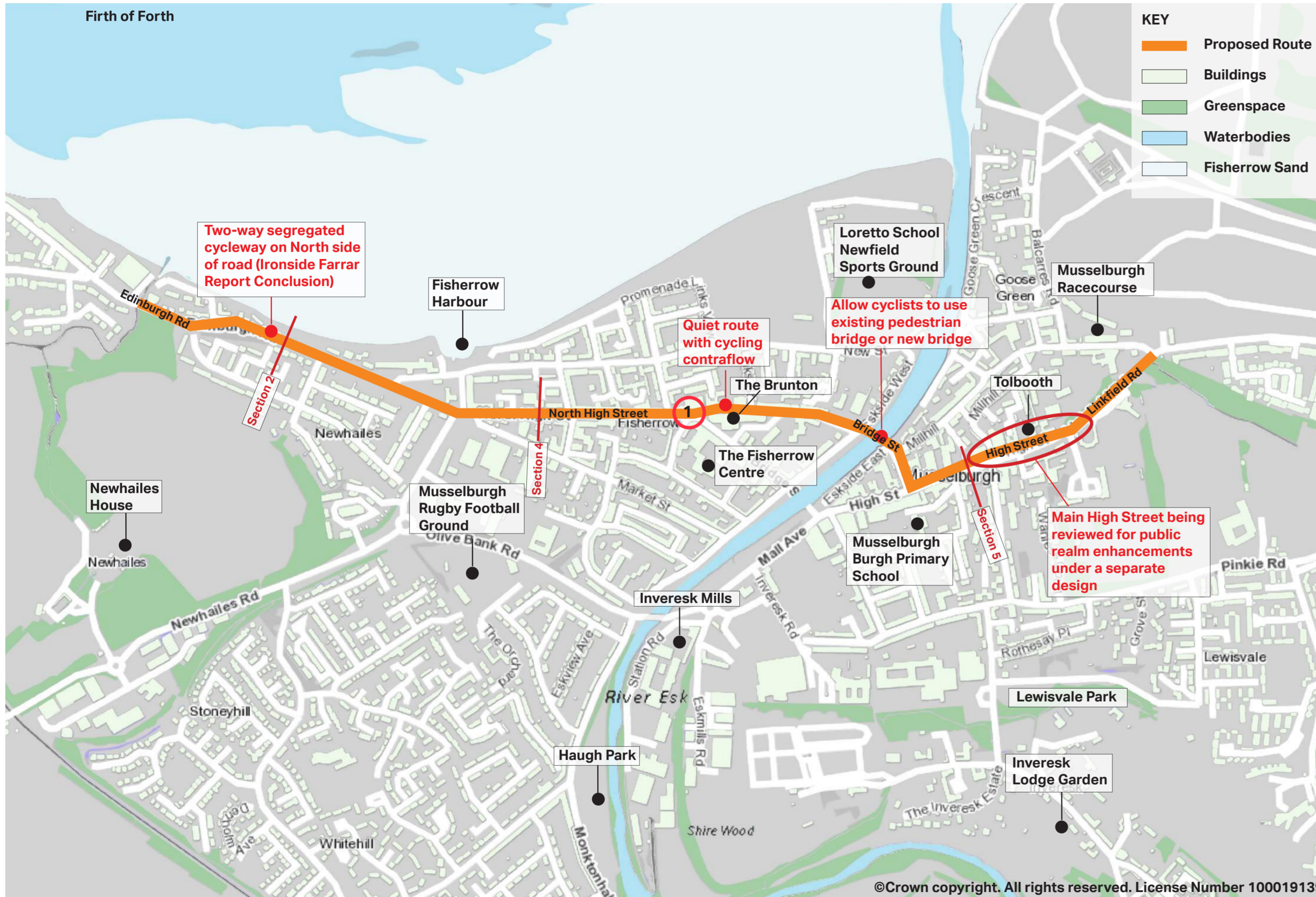

1 Proposal between North High Street and Bridge Street

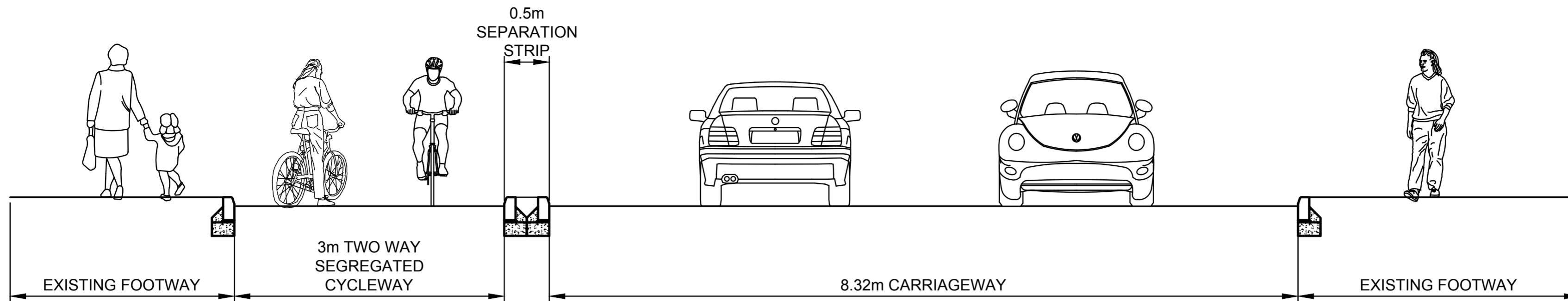

SECTION 2

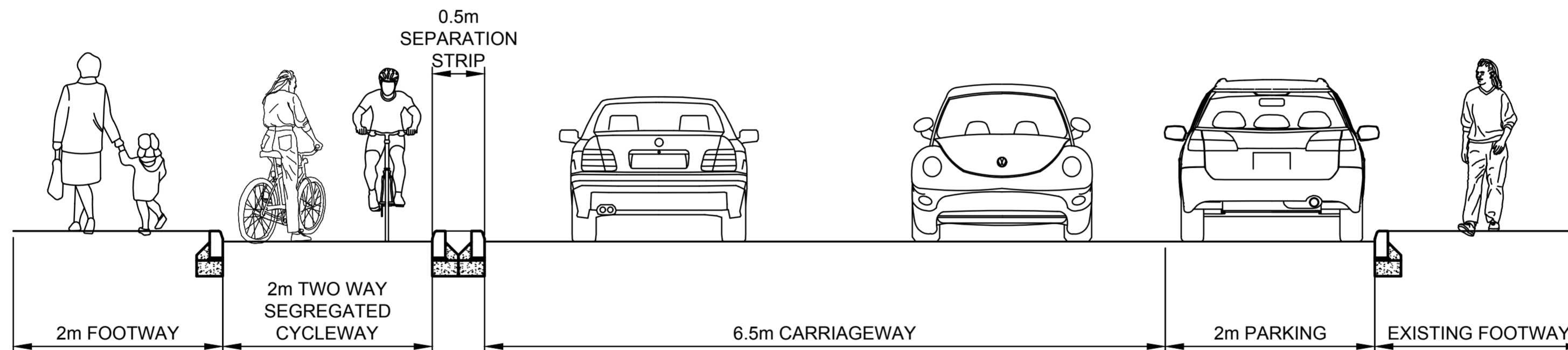

SECTION 4

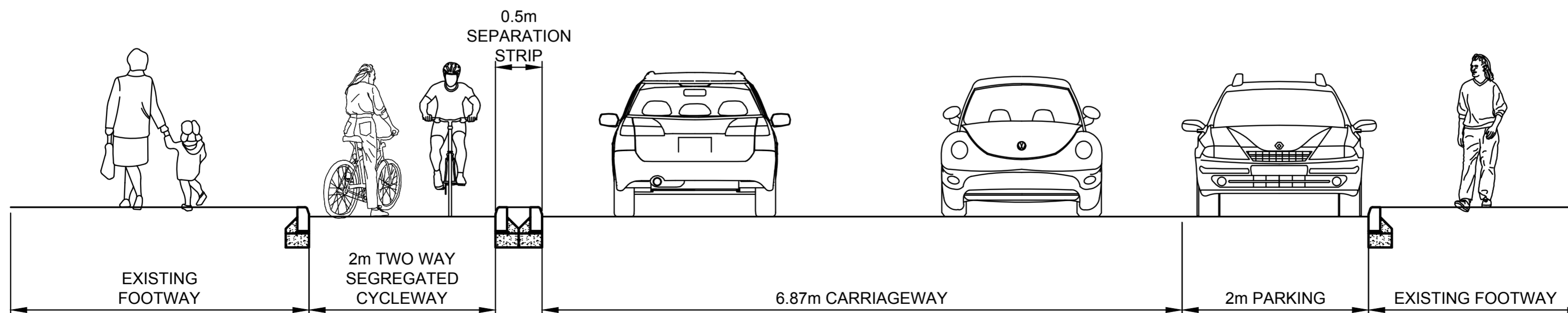

SECTION 5

ROUTE 2



1 Proposal of Linkfield Rd

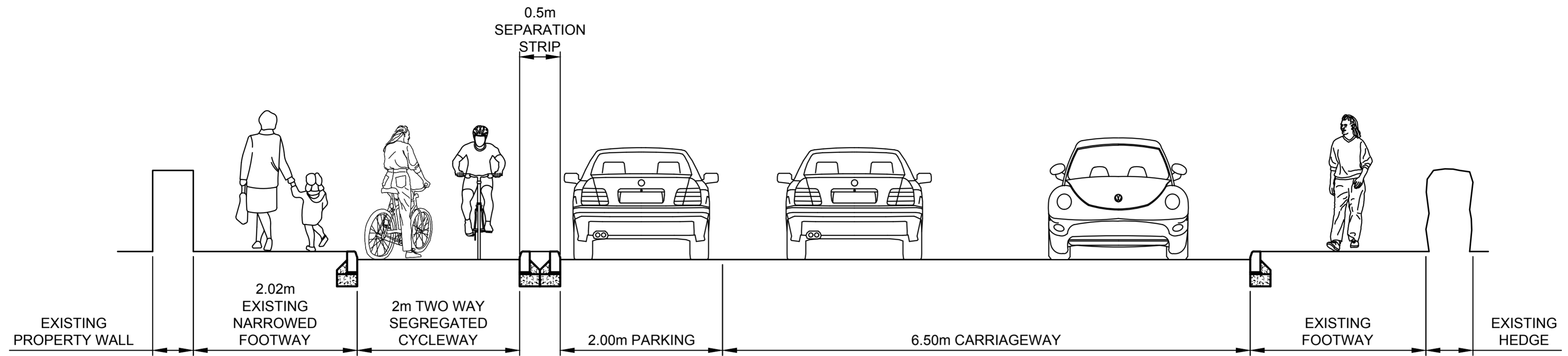

SECTION 1

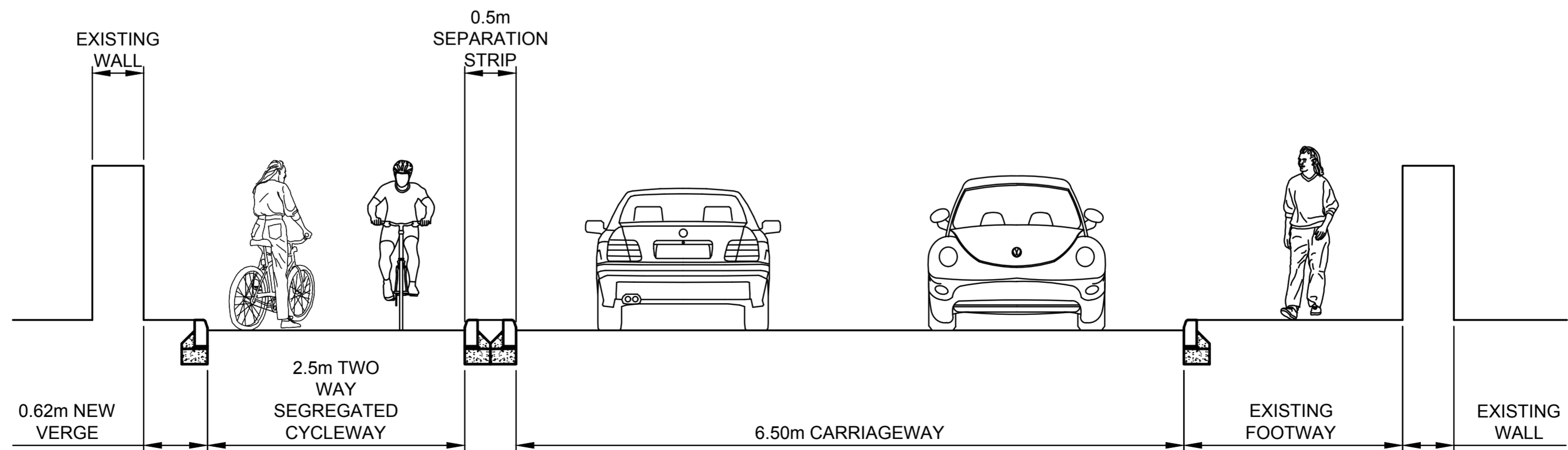

SECTION 2

ROUTE 3



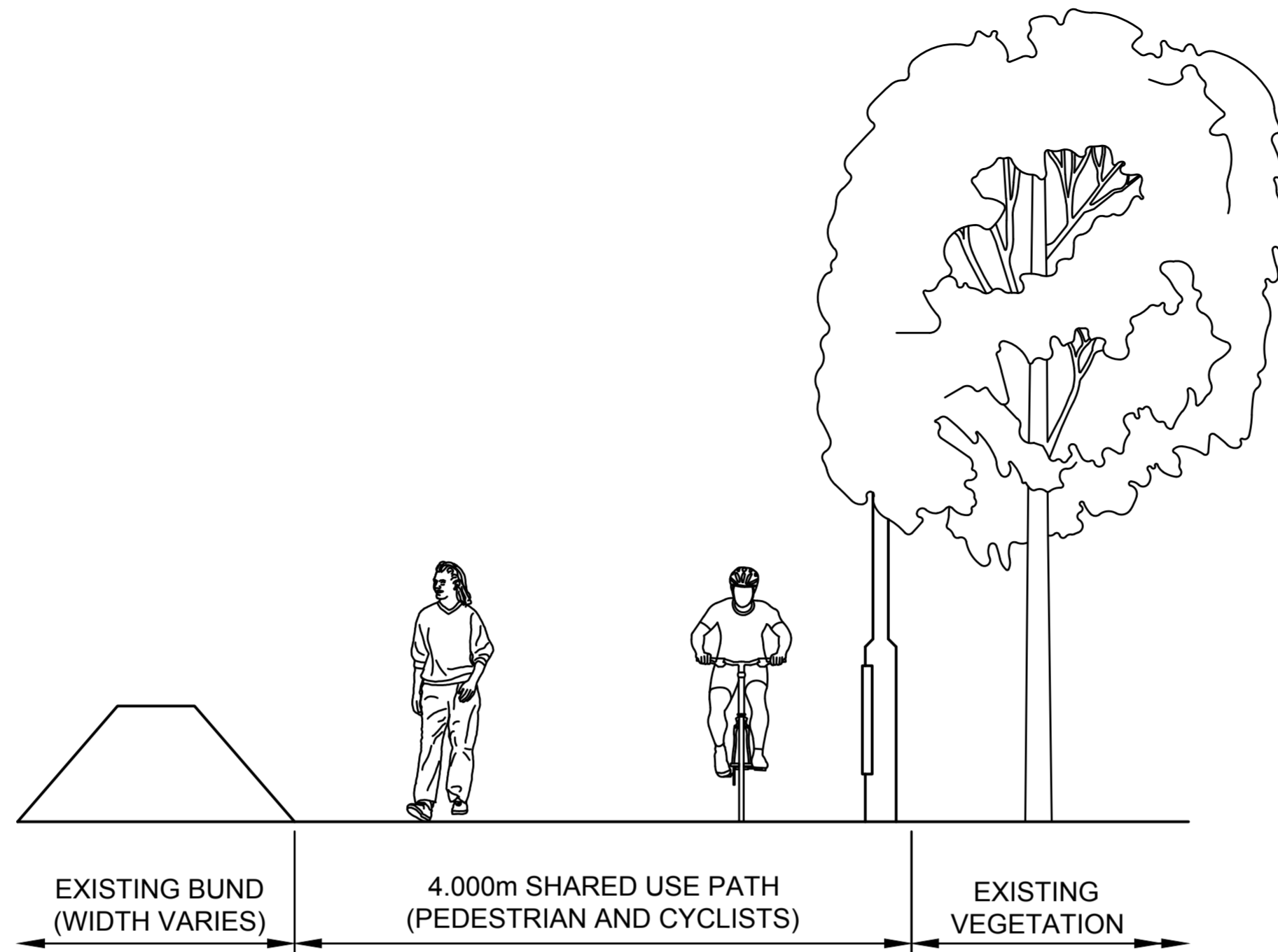

SECTION 1

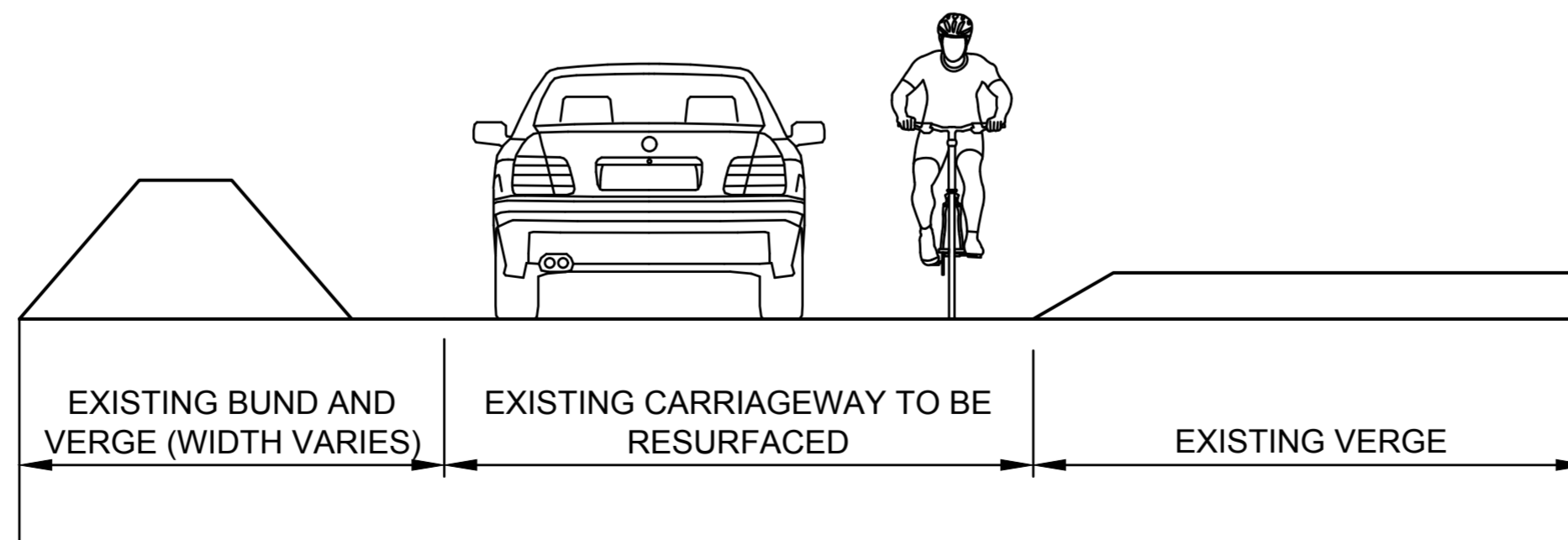

SECTION 2

ROUTE 4

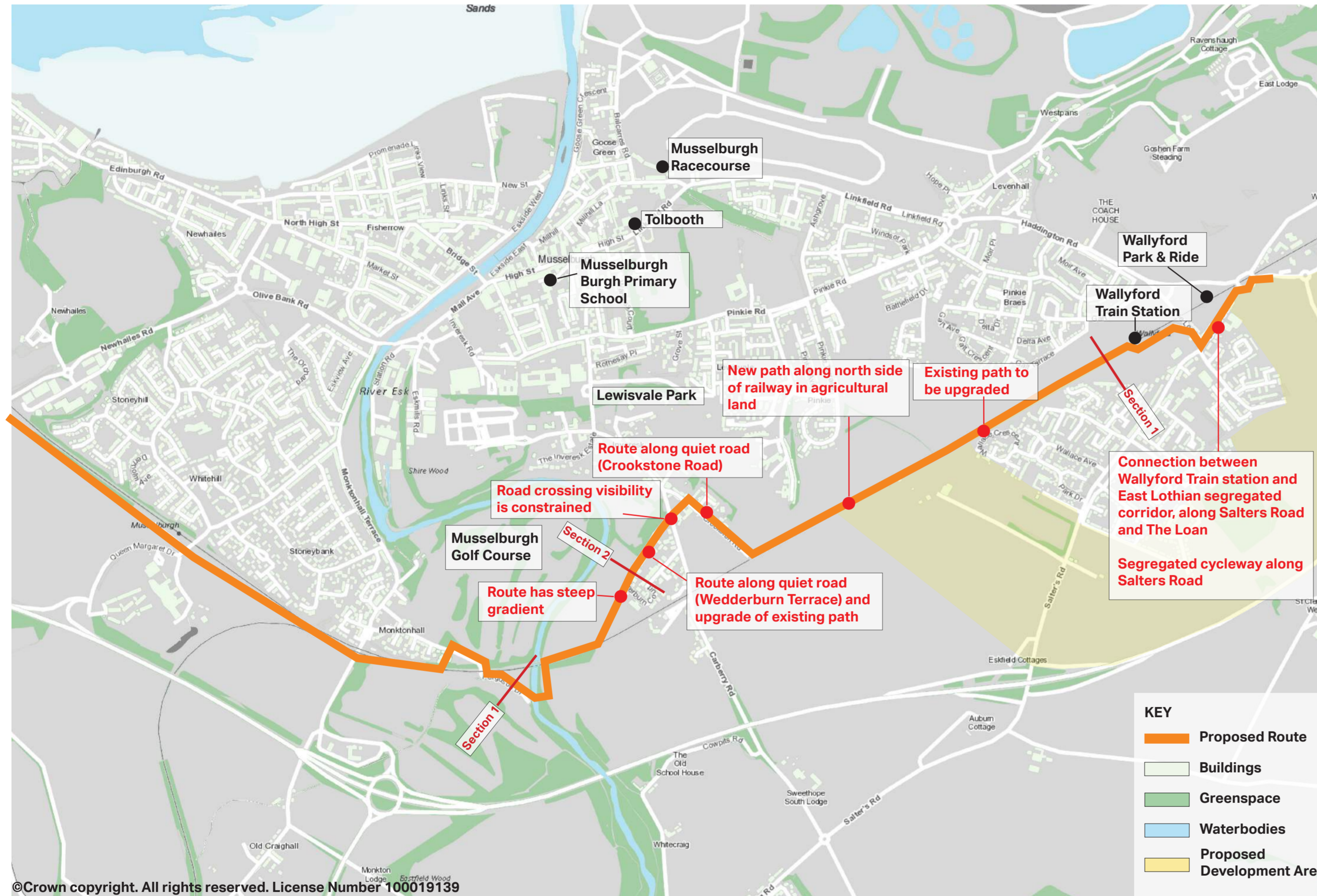

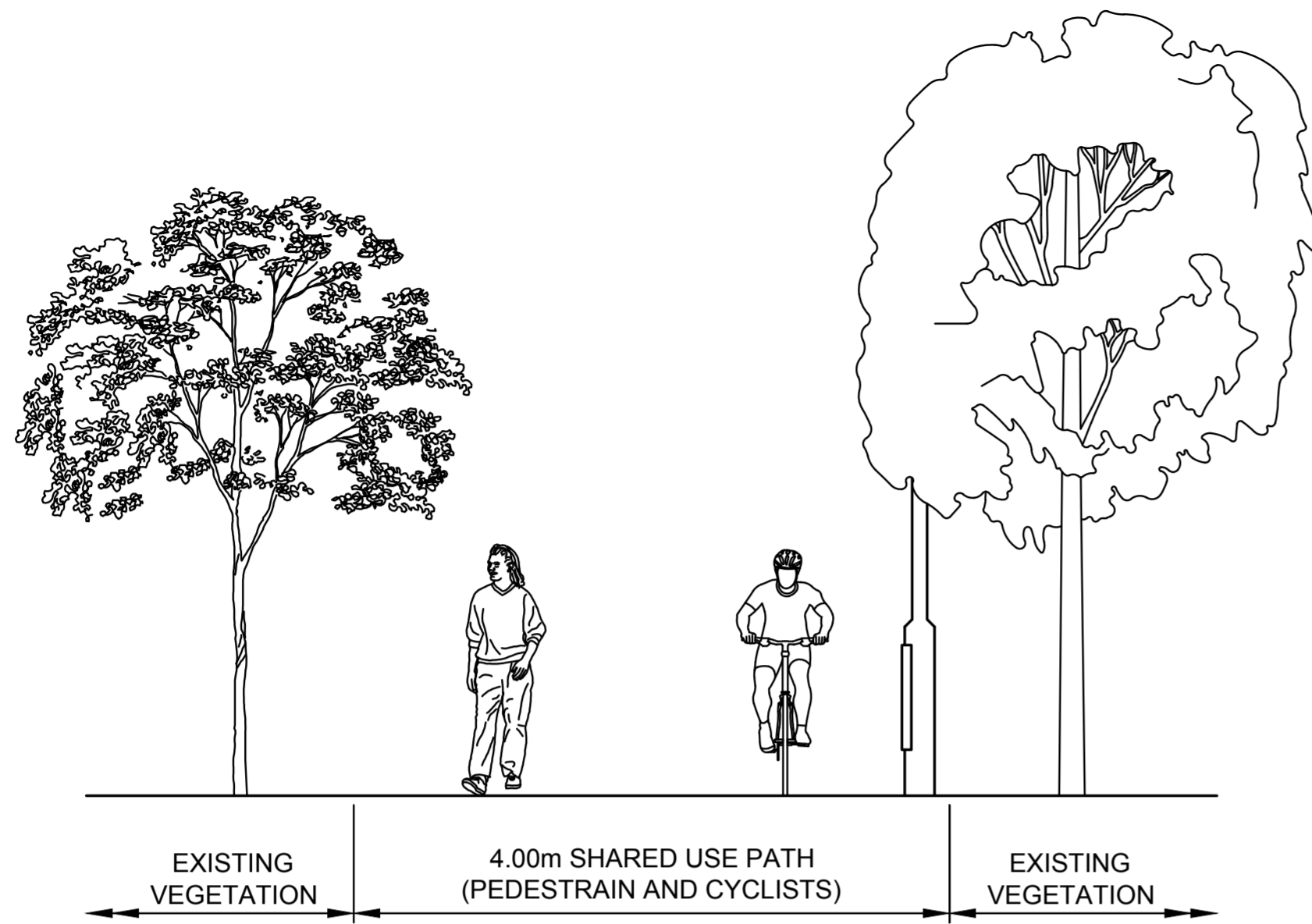

SECTION 1

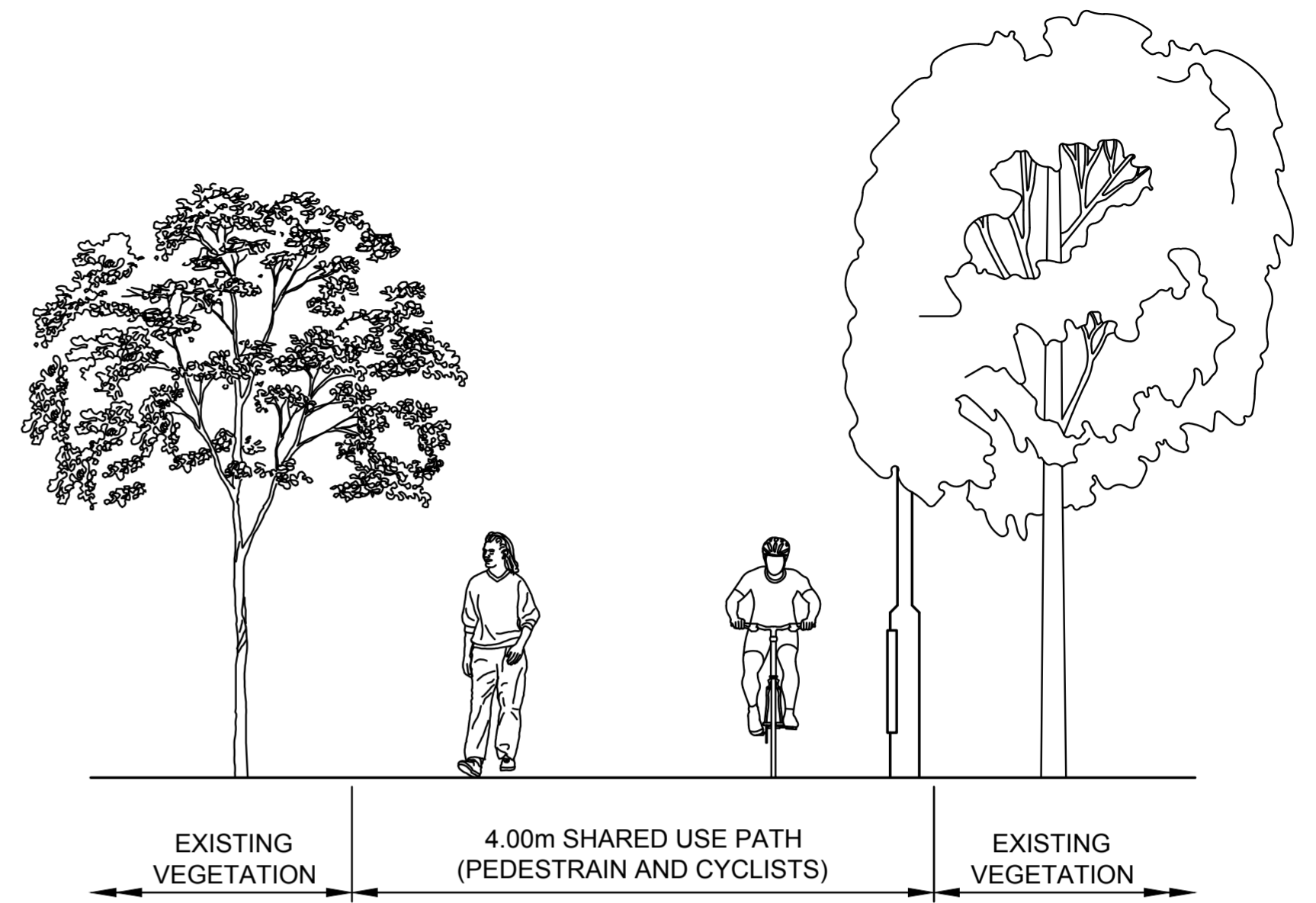

SECTION 1

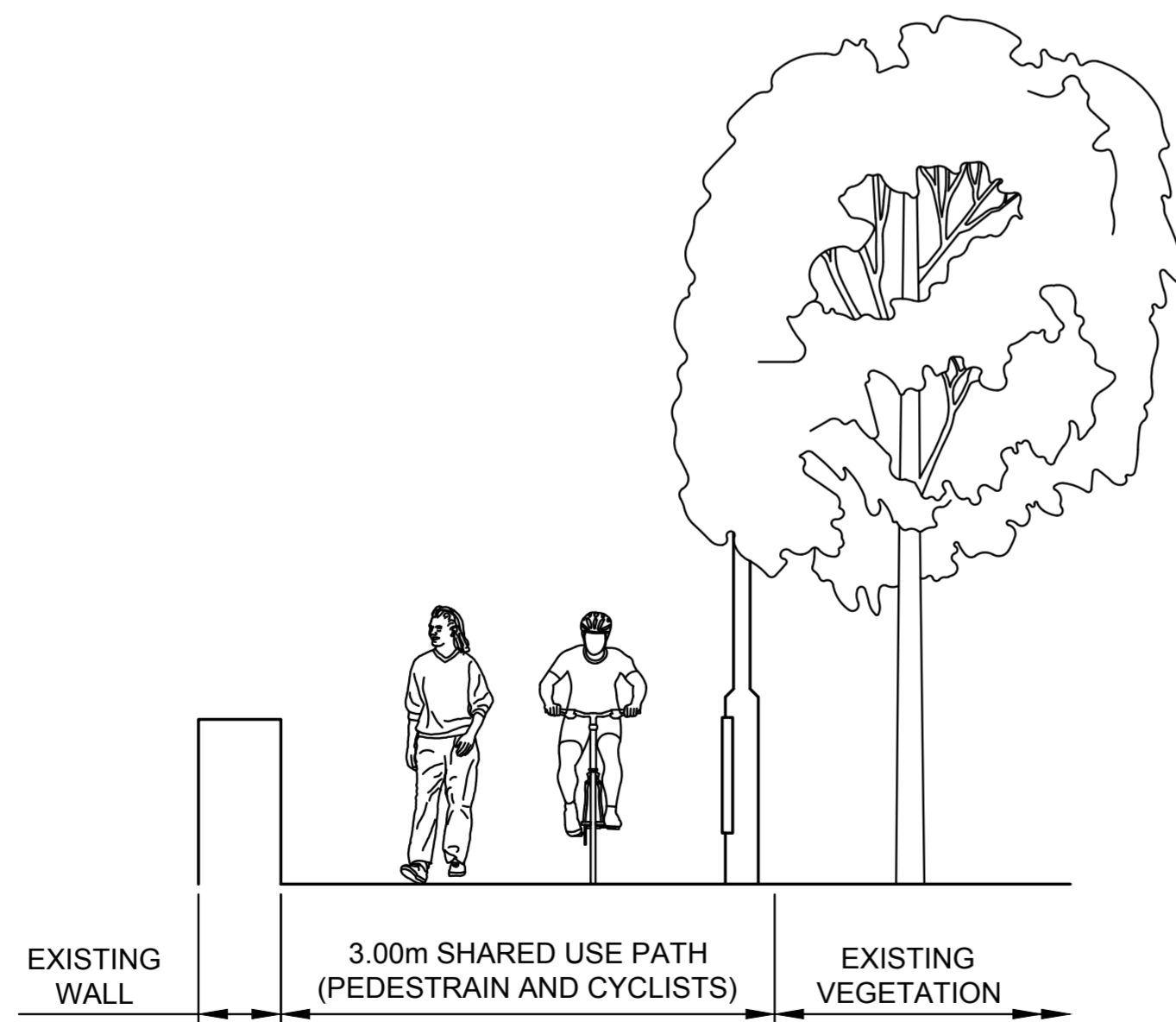

SECTION 2

ROUTE 5



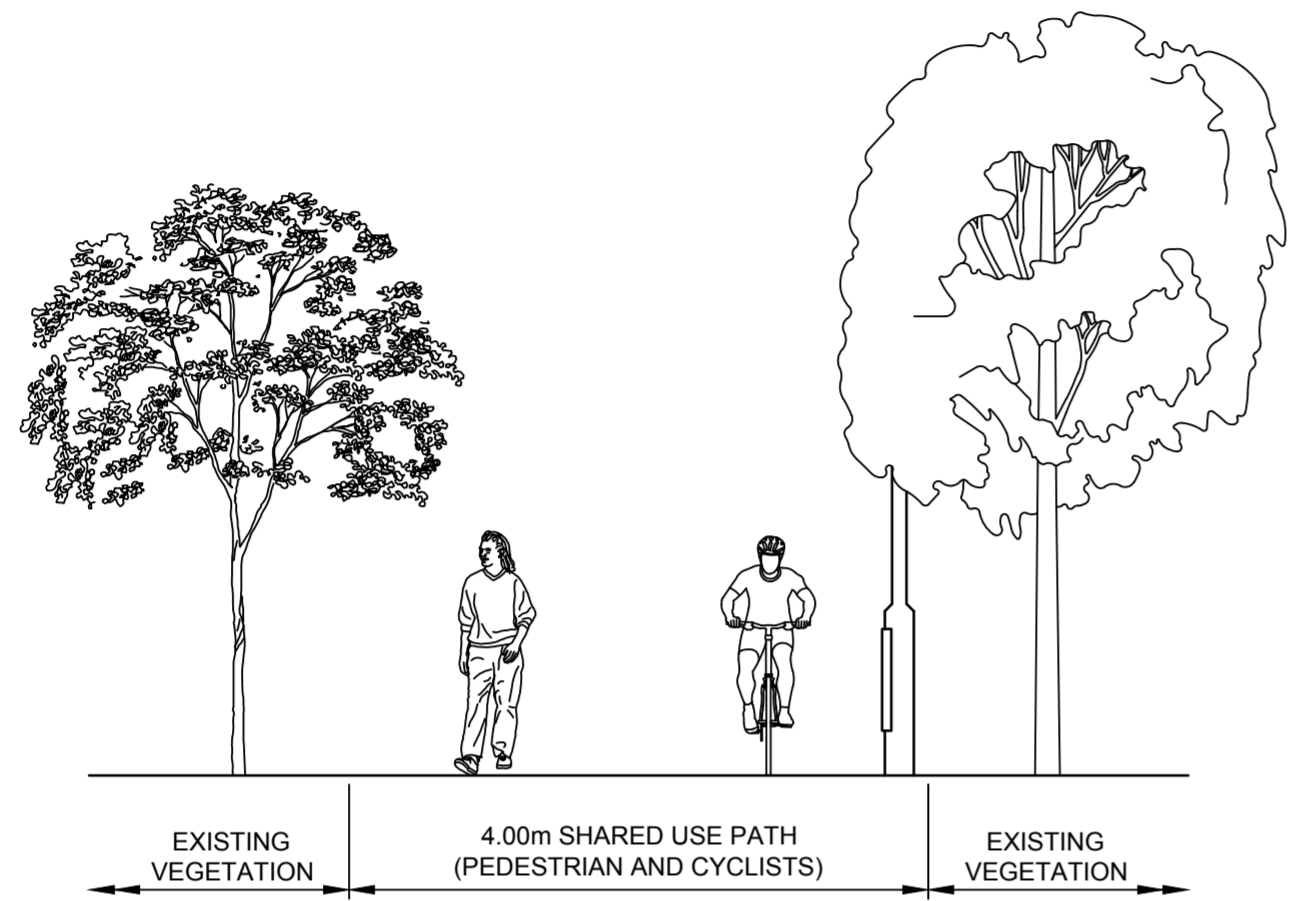

SECTION 1

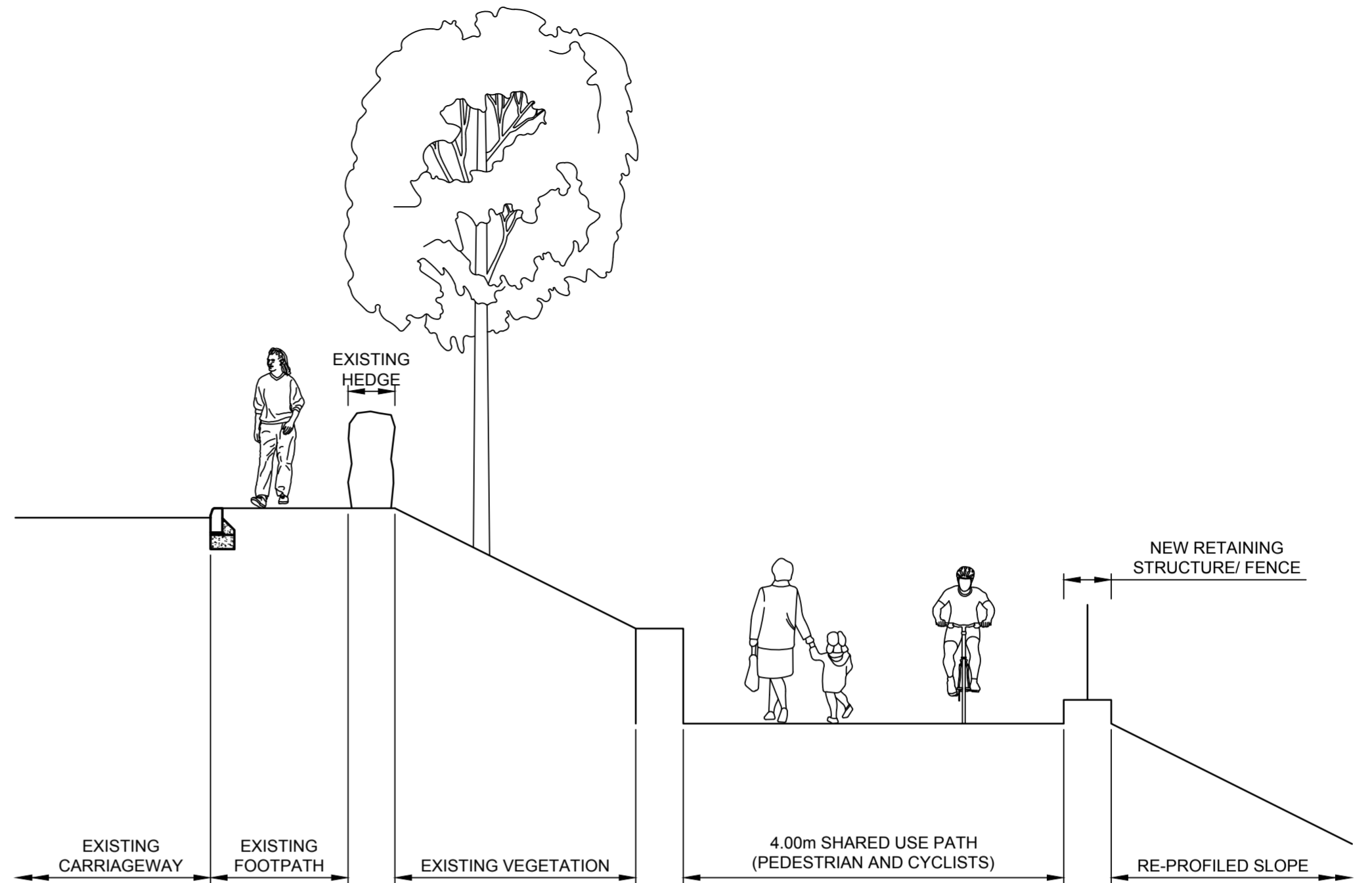

SECTION 3

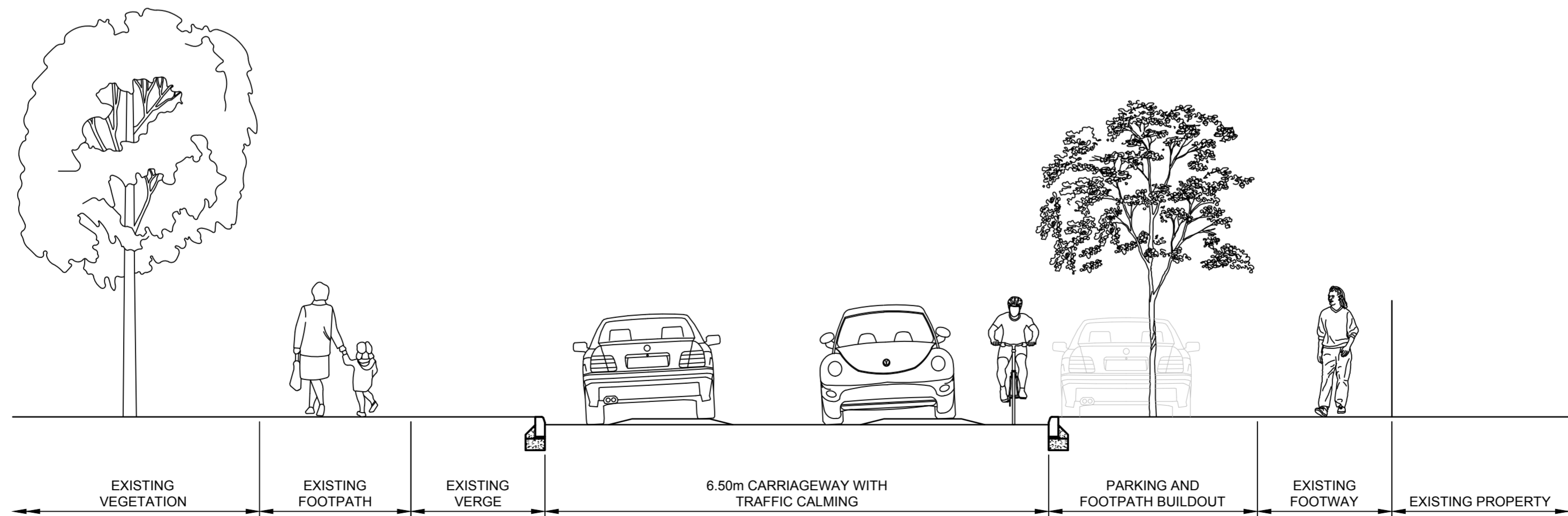

SECTION 2

ROUTE 6



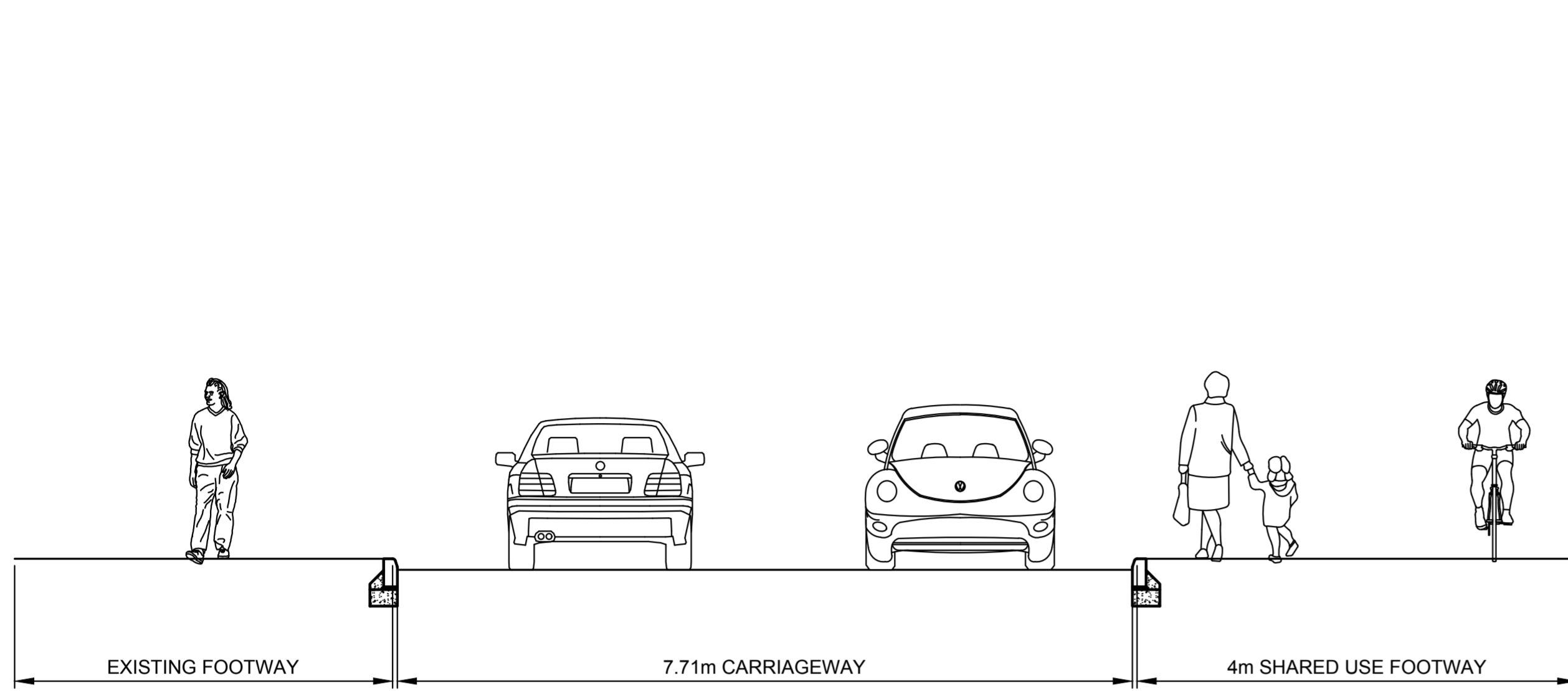

SECTION 1

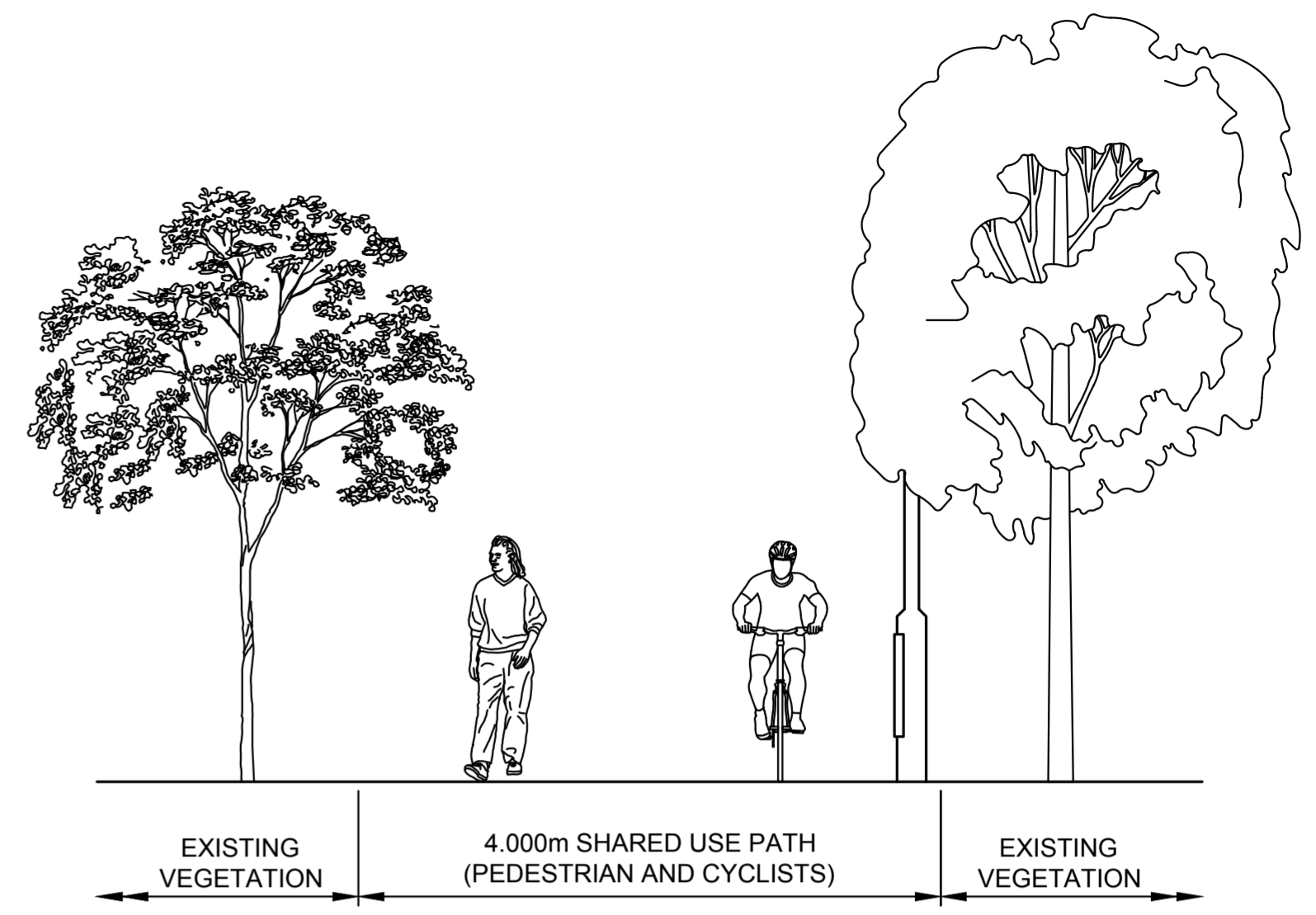

SECTION 2

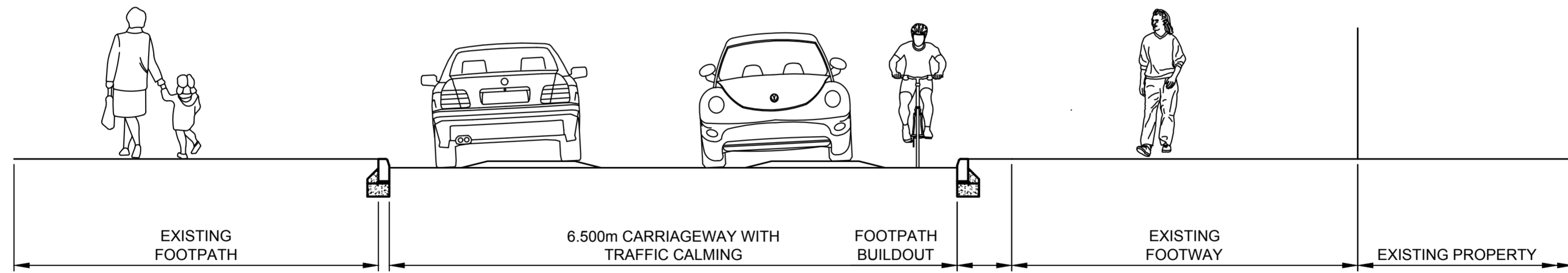

SECTION 3

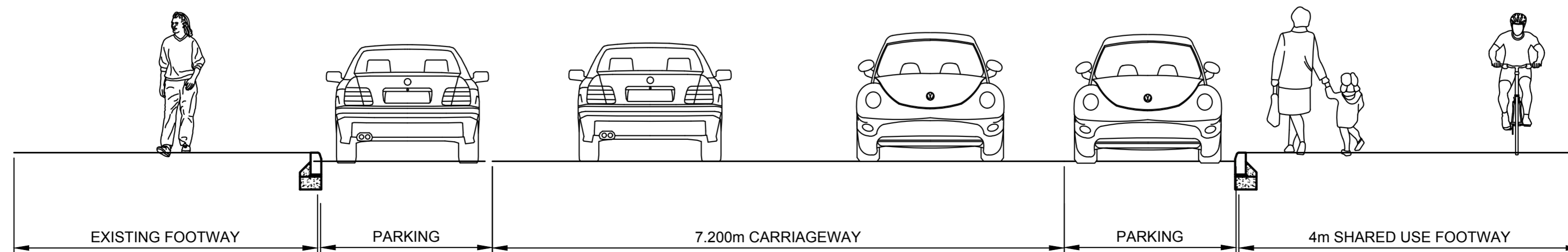

SECTION 4

ROUTE 7



ROUTE 8

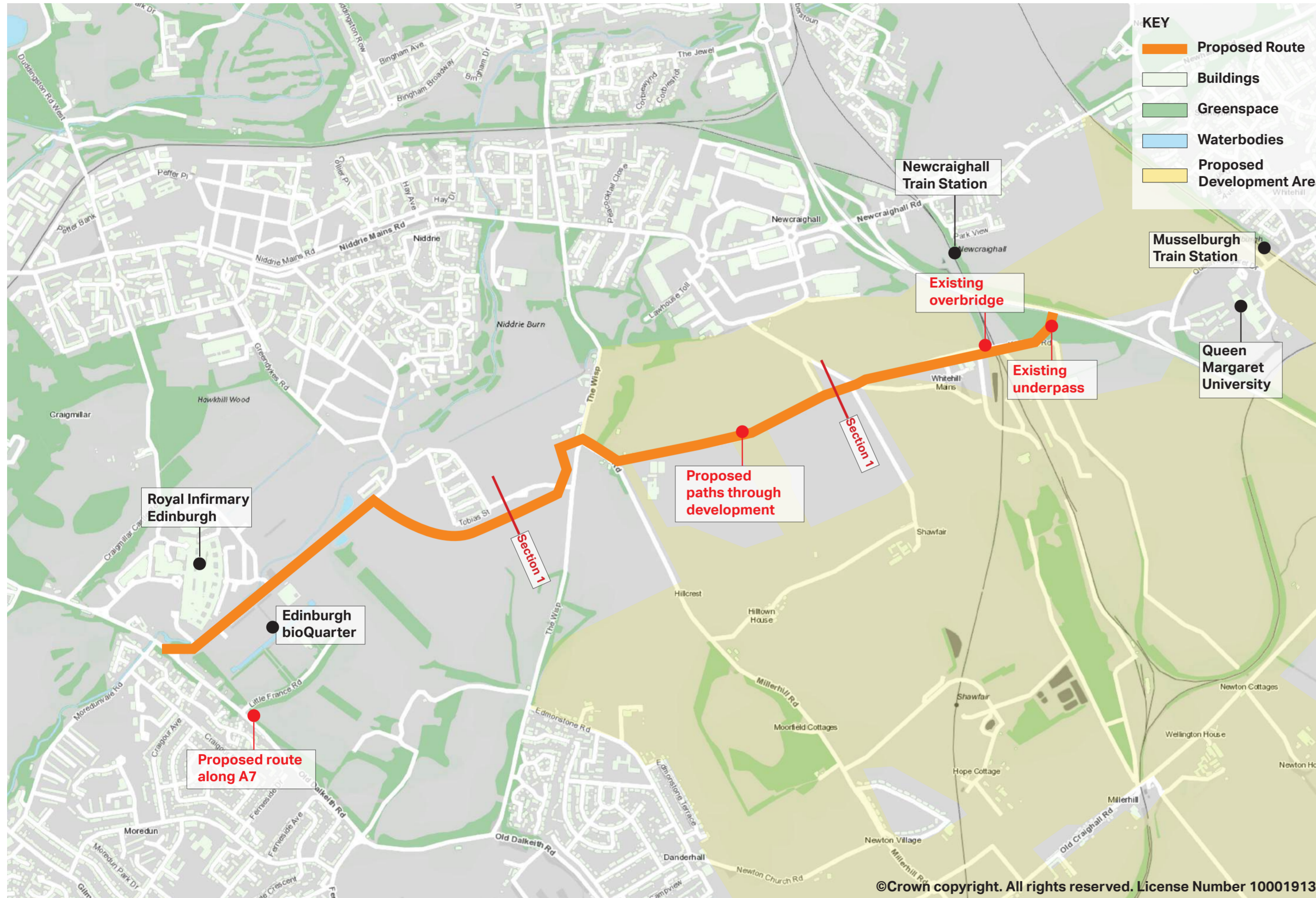

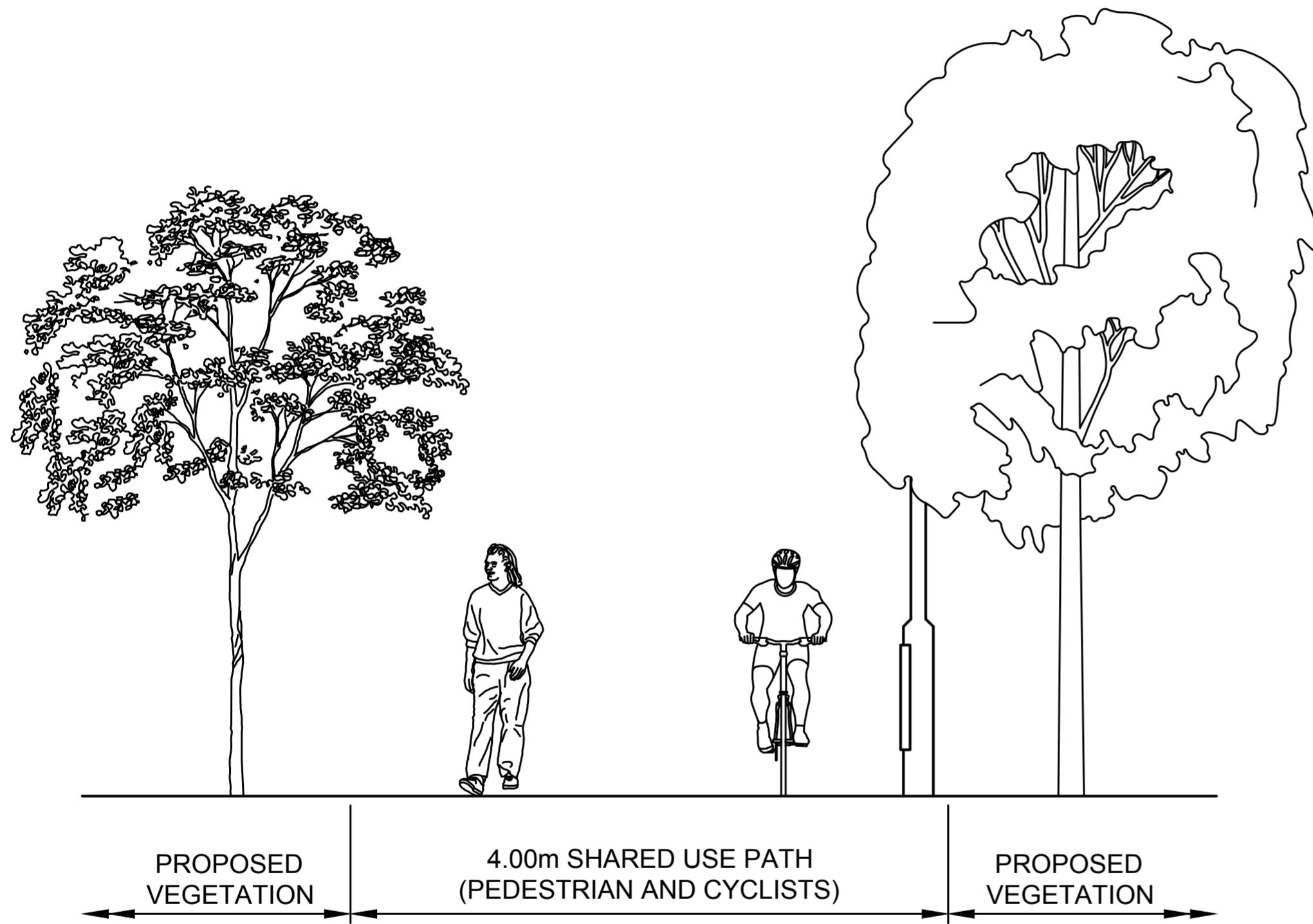

SECTION 1

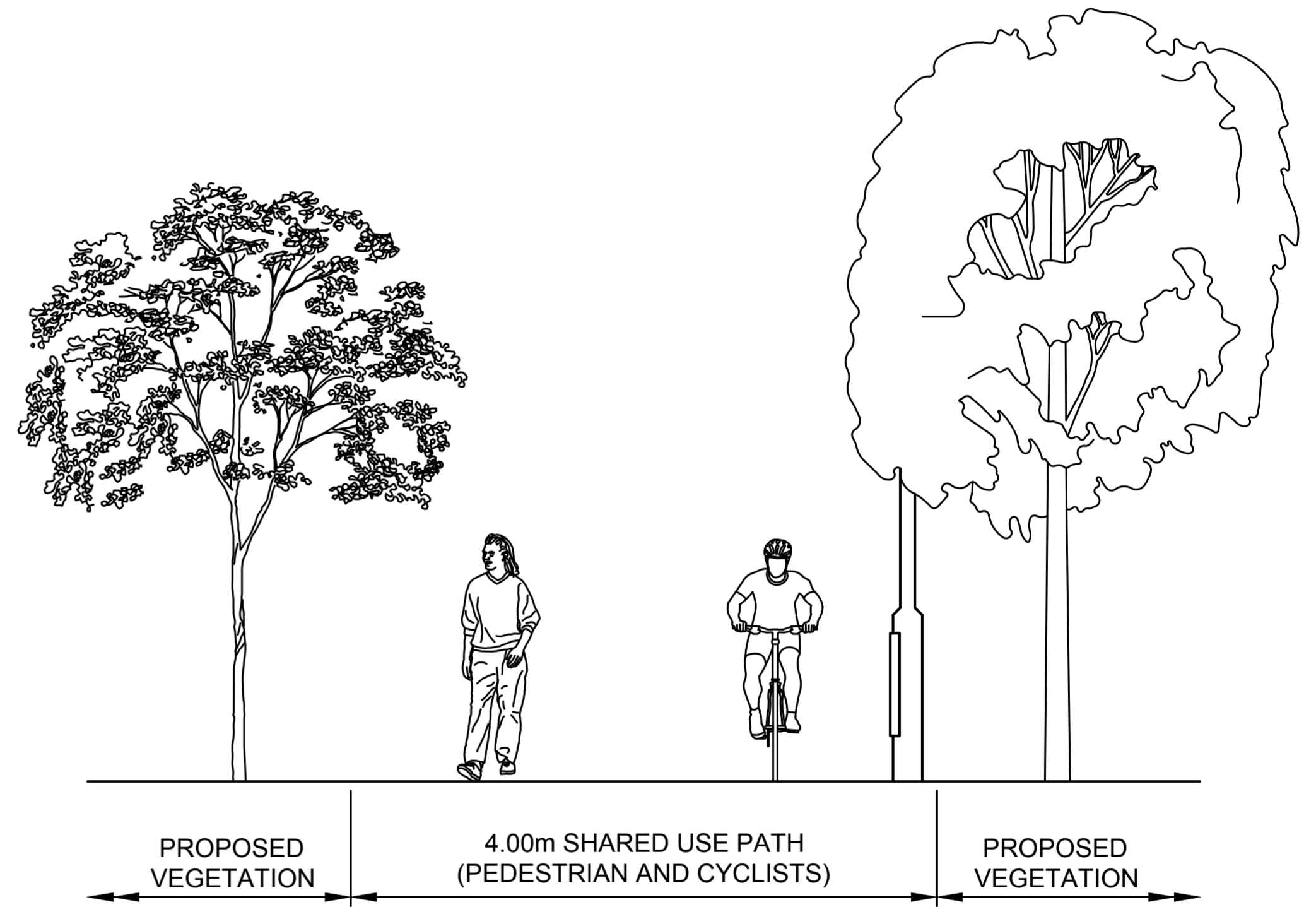

SECTION 1

ROUTE 9



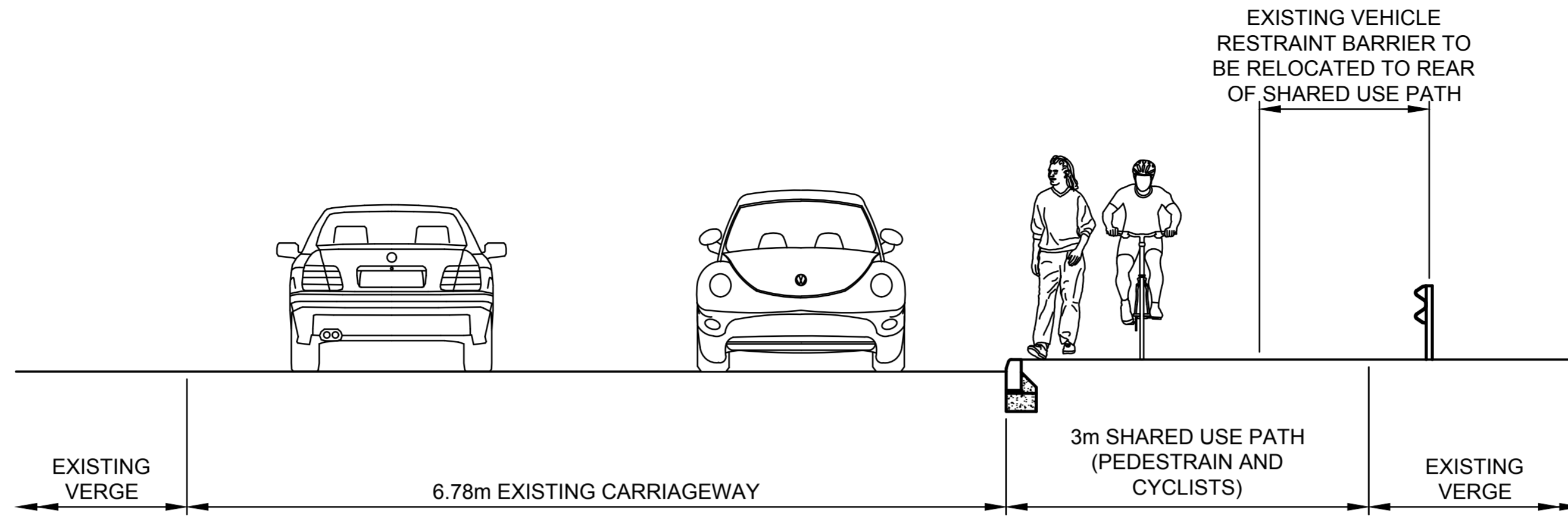

SECTION 2

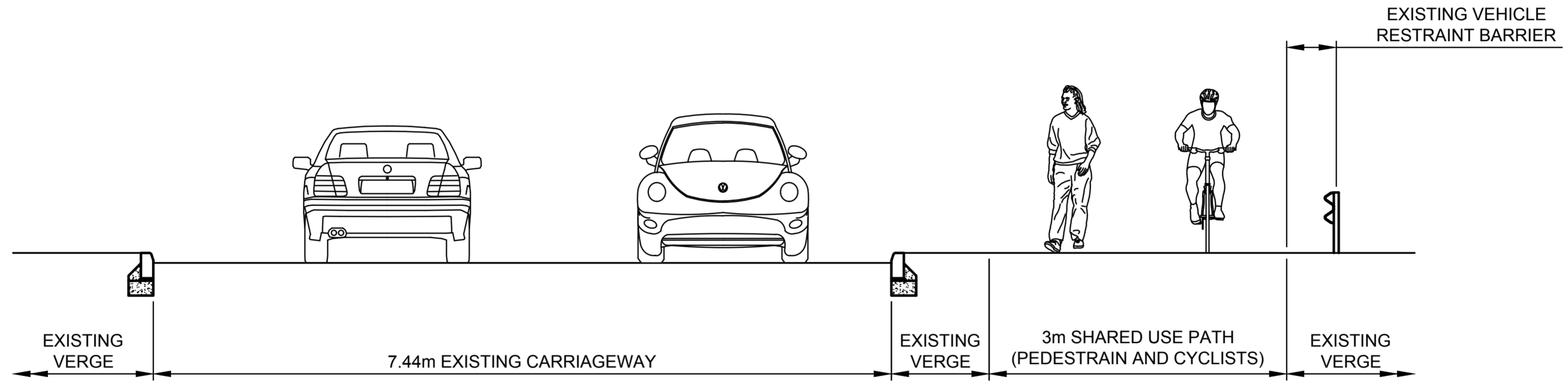

SECTION 3

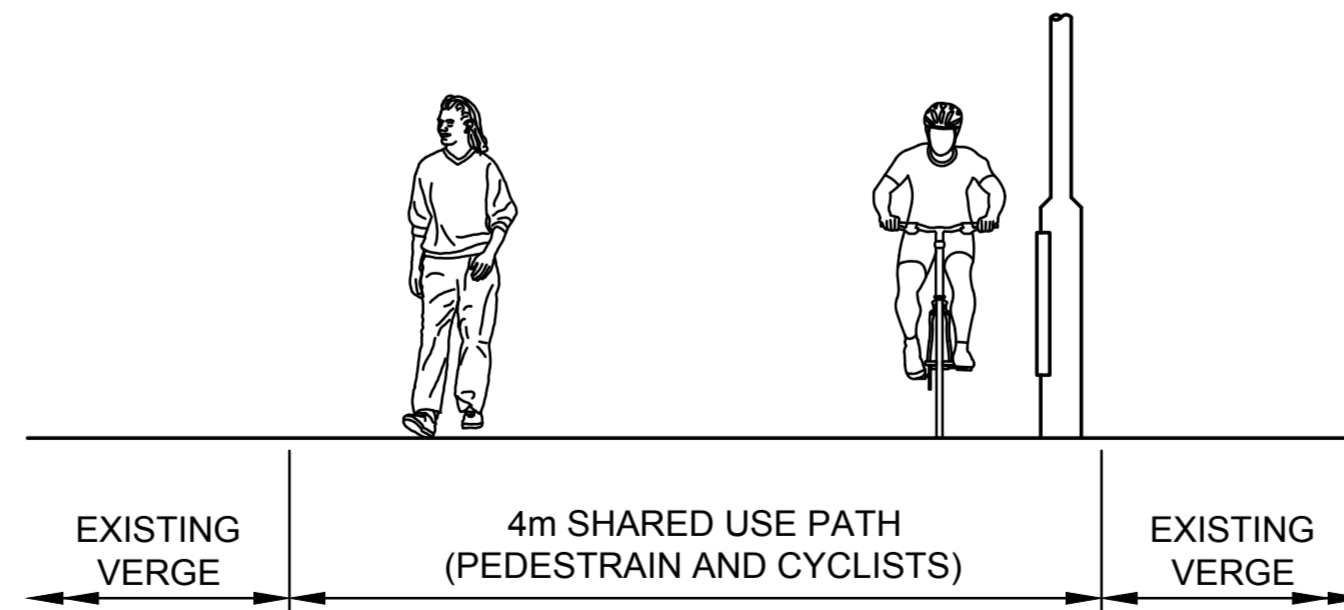

SECTION 4